



POWERSPORTS BATTERY Factory Activated Sealed Battery Series

CTZ5S 12V 3.5AH(10HR)



JIS
D5302

Specification

BATTERY TYPE NUMBER	VOLTAGE (V)	CAPACITY AH (10HR)	CCA @-18°C	MAXIMUM DIMENSIONS						WEIGHT			
				MILLIMETERS (±2 mm)			INCHES (±1/16 in)			BATTERY WITH ACID		INCLUDE PACKAGE	
				L	W	H	L	W	H	Kg	Lbs	Kg	Lbs
CTZ5S	12	3.5	65	113	70	88	4 7/16	2 3/4	3 7/16	1.60	3.52	1.66	3.66

Dimension

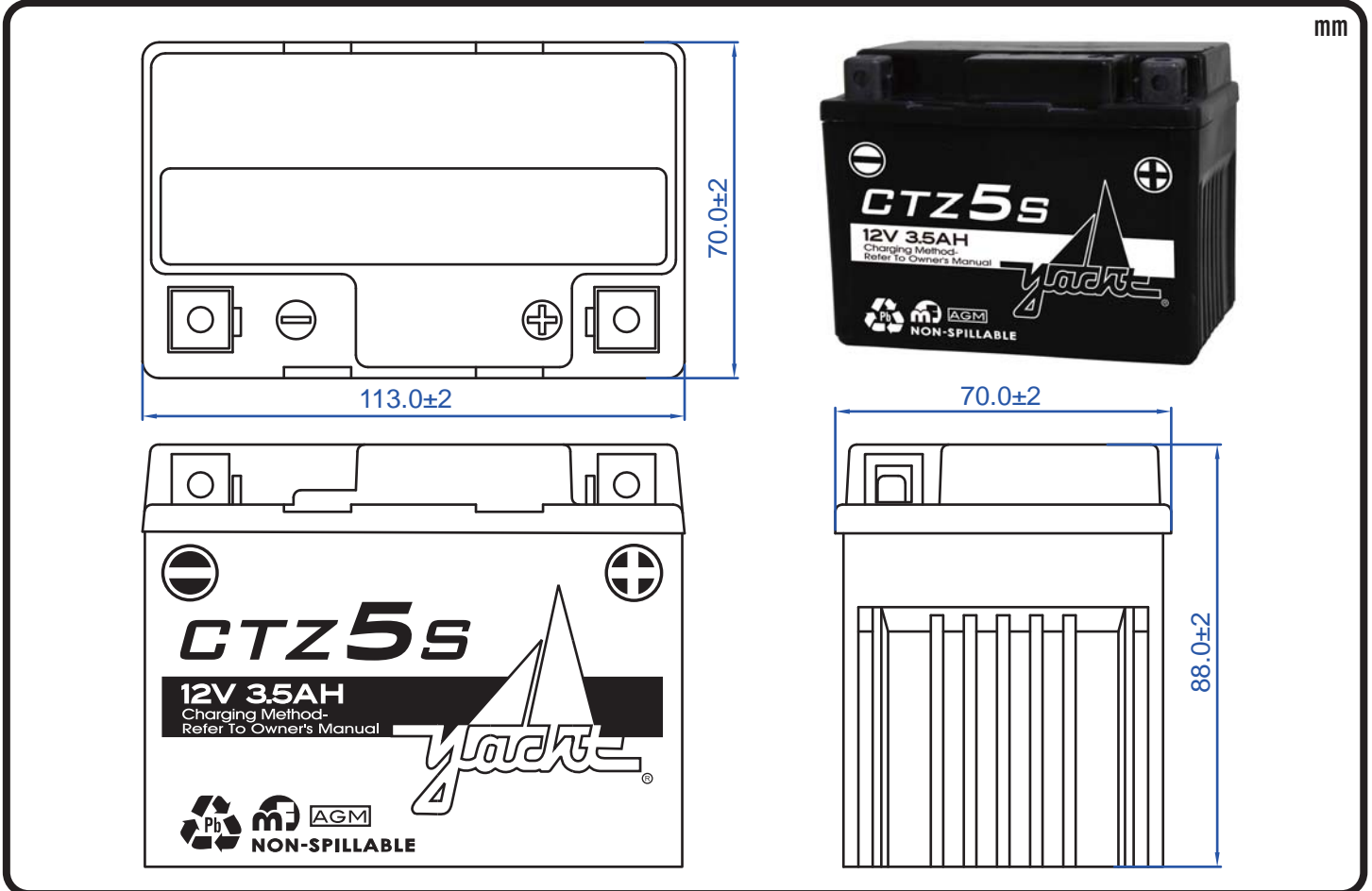

Terminal Configuration

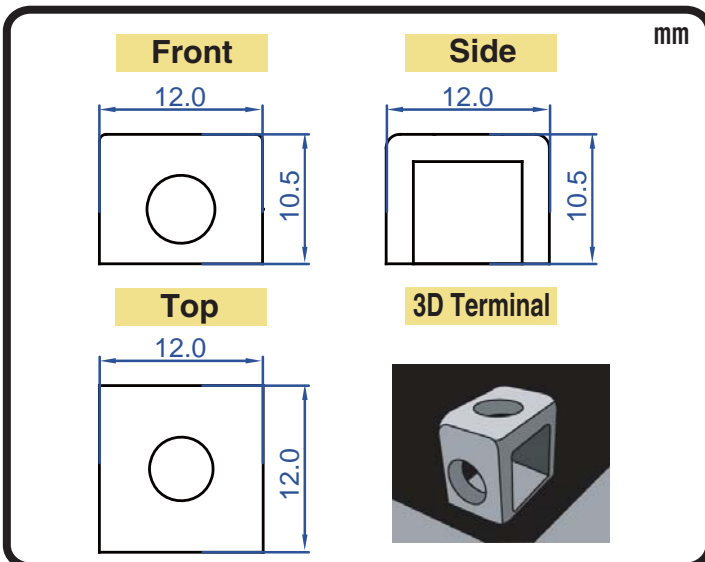

Nut & Bolt Hardware Kits

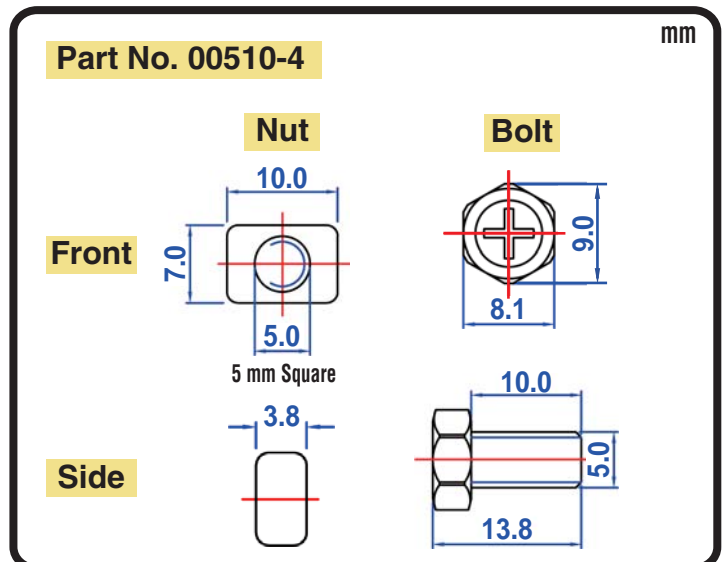

CORPORATE HEADQUARTERS (TAICHUNG, TAIWAN)
 4F-5, No. 925, Sec. 4, Taiwan Blvd., Taichung, 40767 Taiwan, R.O.C.
 Tel : 886-4-2358-0578 Fax : 886-4-2358-0059
 sales@yacht-battery.com

YACHT BATTERY USA, INC.
 Tel : 1-610-689-0443 Fax : 1-888-373-6466
 Dave.Beidler@yacht-battery.com
 Bruce.Ash@yacht-battery.com