



POWERSPORTS BATTERY Factory Activated Sealed Battery Series

CTX19L (FA) 12V 19AH(10HR)



JIS
D5302

Specification

BATTERY TYPE NUMBER	VOLTAGE (V)	CAPACITY AH (10HR)	CCA @-18°C	MAXIMUM DIMENSIONS						WEIGHT			
				MILLIMETERS (±2 mm)			INCHES (±1/16 in)			BATTERY WITH ACID		INCLUDE PACKAGE	
				L	W	H	L	W	H	Kg	Lbs	Kg	Lbs
CTX19L (FA)	12	19	260	175	101	157	6 7/8	3 15/16	6 3/16	7.02	15.45	7.28	16.04

Dimension

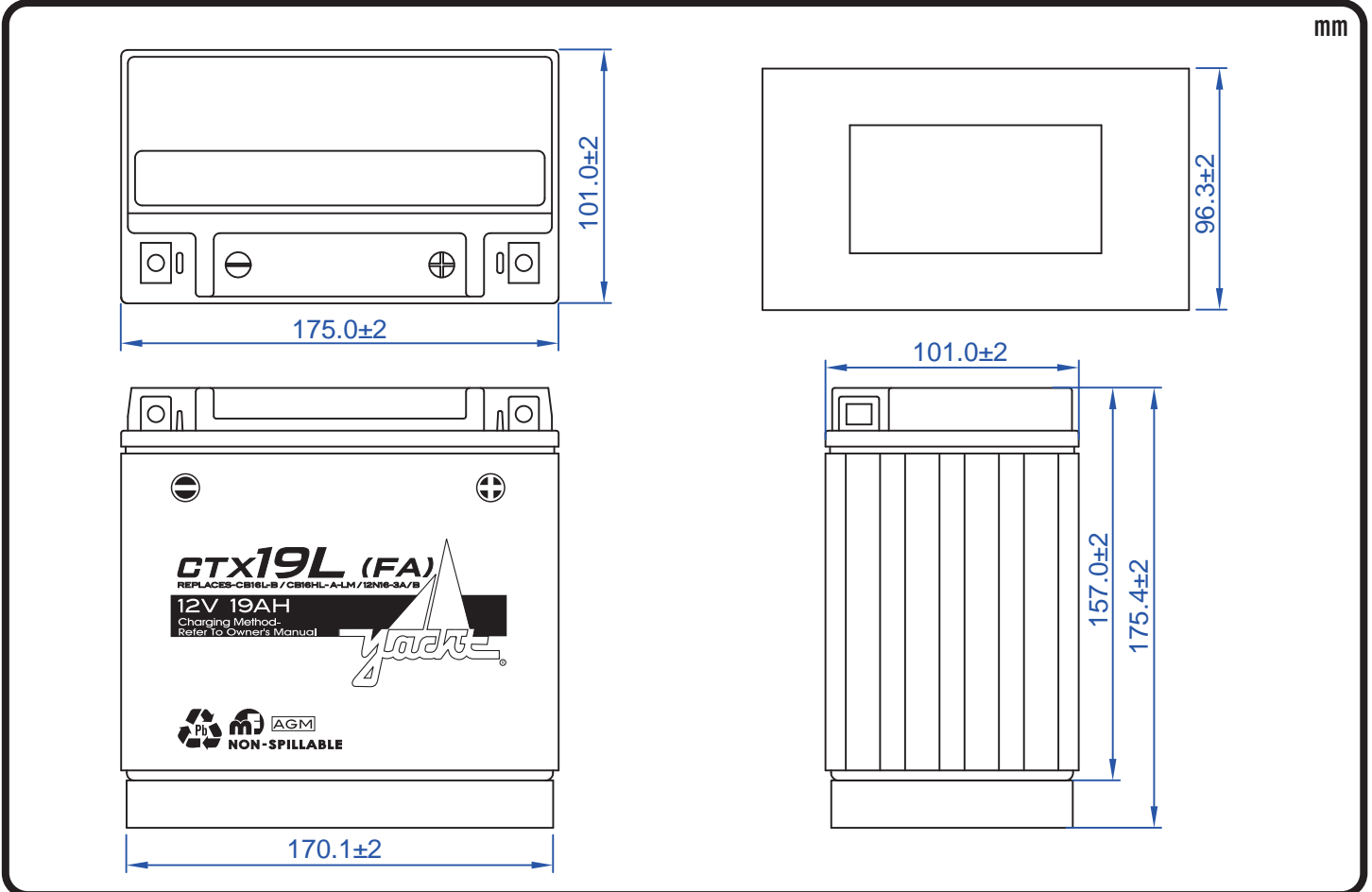

Terminal Configuration

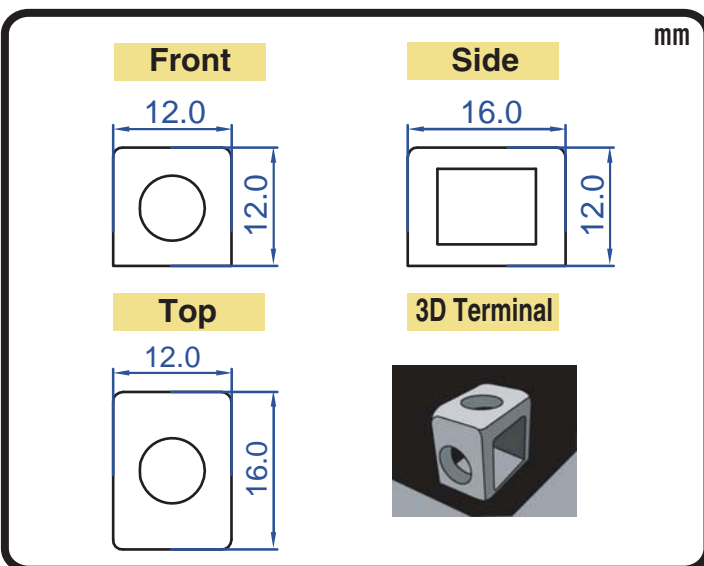

Nut & Bolt Hardware Kits

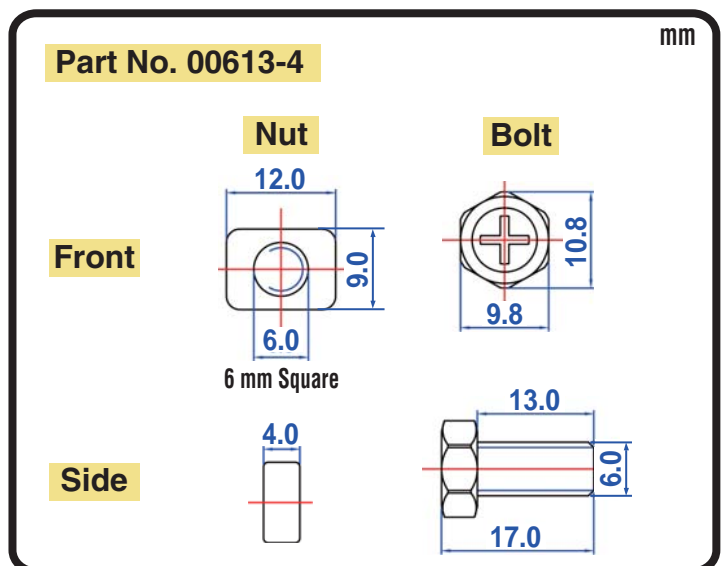

CORPORATE HEADQUARTERS (TAICHUNG, TAIWAN)

4F-5, No. 925, Sec. 4, Taiwan Blvd., Taichung, 40767 Taiwan, R.O.C.
Tel : 886-4-2358-0578 Fax : 886-4-2358-0059
sales@yacht-battery.com

YACHT BATTERY USA, INC.

Tel : 1-610-689-0443 Fax : 1-888-373-6466
Dave.Beidler@yacht-battery.com
Bruce.Ash@yacht-battery.com