



AUXILIARY BATTERY Factory Activated Sealed Battery Series

AUX9 12V 8AH(10HR) / 9AH(20HR)



JIS
D5302

Specification

BATTERY TYPE NUMBER	VOLTAGE (V)	CAPACITY AH		CCA @-18°C	MAXIMUM DIMENSIONS						WEIGHT			
		(10HR)	(20HR)		MILLIMETERS(±2 mm)			INCHES (±1/16 in)			BATTERY WITH ACID		INCLUDE PACKAGE	
					L	W	H	L	W	H	Kg	Lbs	Kg	Lbs
AUX9	12	8	9	130	150	87	106	5 7/8	3 7/16	4 3/16	3.10	6.83	3.20	7.05

Dimension

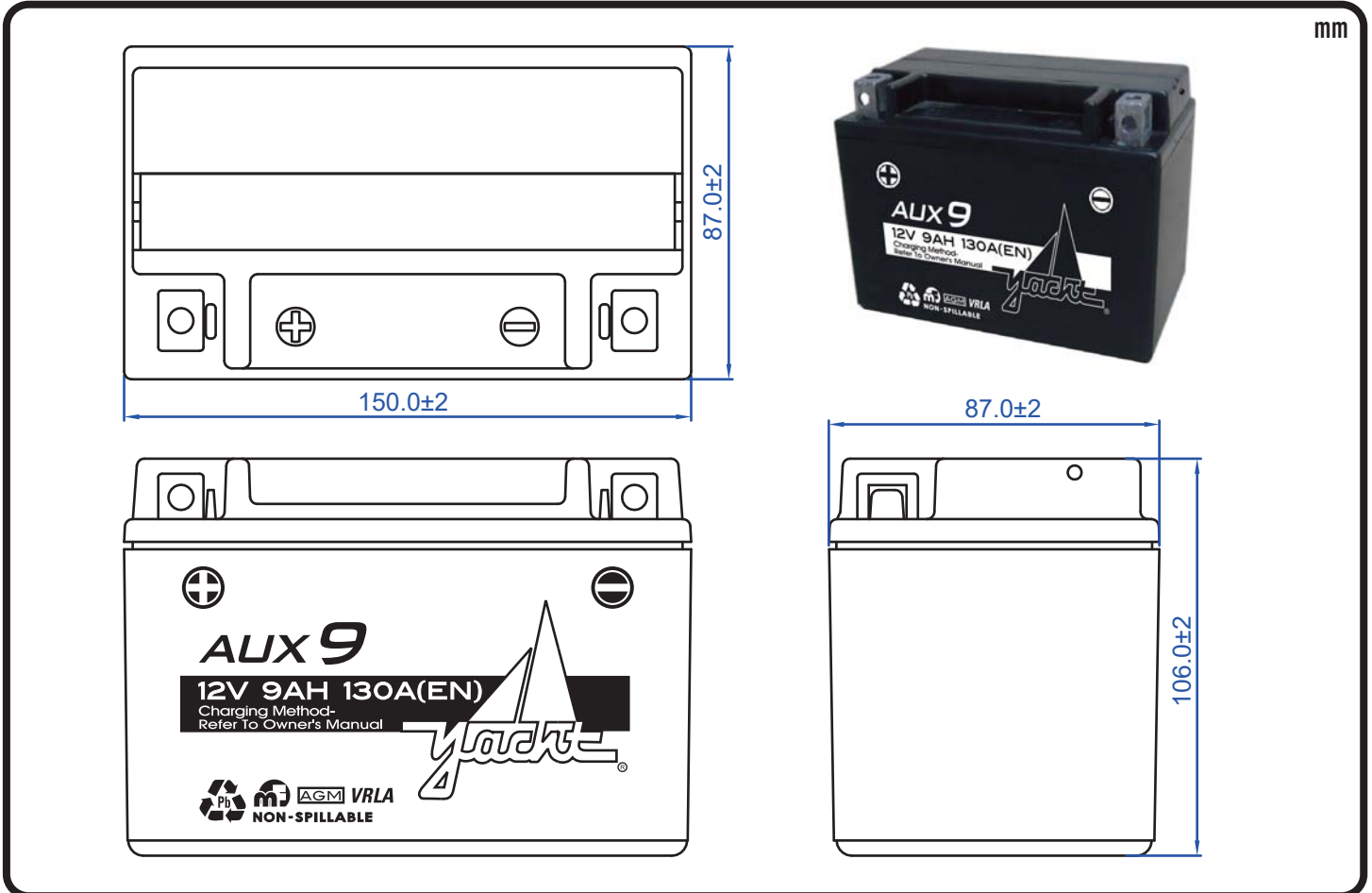

Terminal Configuration

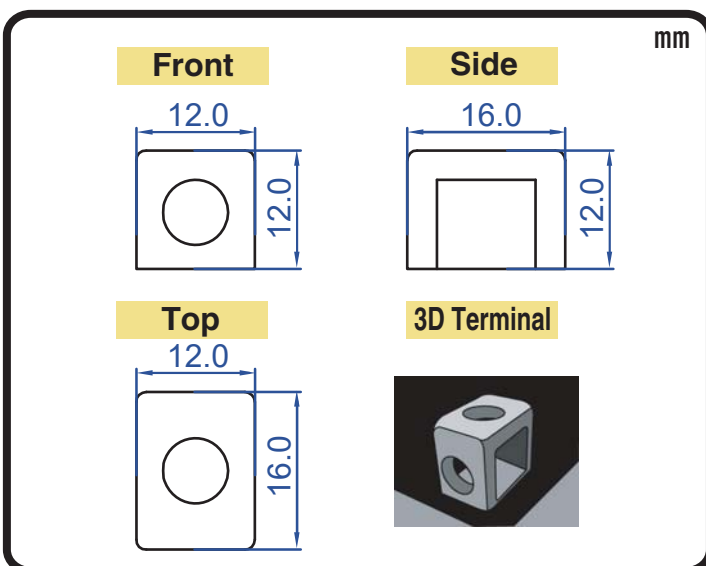

Nut & Bolt Hardware Kits

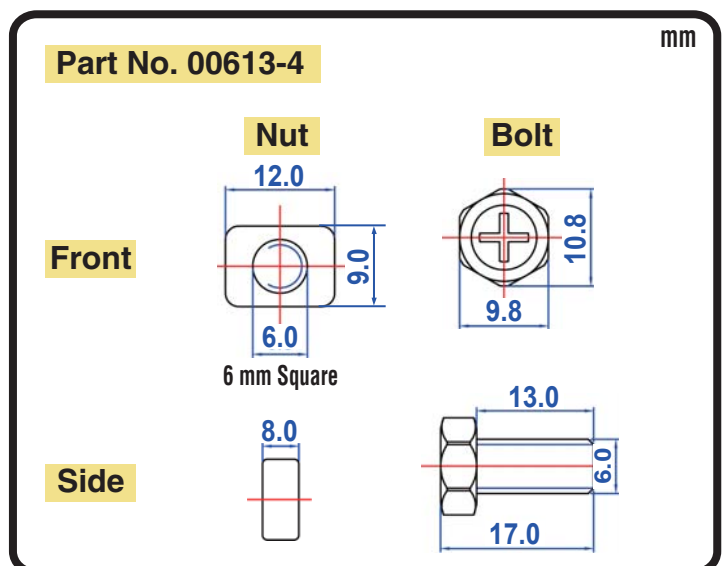

CORPORATE HEADQUARTERS (TAICHUNG, TAIWAN)
4F-5, No. 925, Sec. 4, Taiwan Blvd., Taichung, 40767 Taiwan, R.O.C.
Tel : 886-4-2358-0578 Fax : 886-4-2358-0059
sales@yacht-battery.com

YACHT BATTERY USA, INC.
Tel : 1-610-689-0443 Fax : 1-888-373-6466
Dave.Beidler@yacht-battery.com
Bruce.Ash@yacht-battery.com