



# POWERSPORTS BATTERY

# 6-Volt Conventional Battery Series

## 6N4-2A-8 6V 4AH(10HR)



JIS  
D5302

### Specification

BATTERY TYPE NUMBER	VOLTAGE (V)	CAPACITY AH (10HR)	MAXIMUM DIMENSIONS						WEIGHT			
			MILLIMETERS(±2 mm)			INCHES (±1/16 in)			BATTERY ONLY		INCLUDE ACID AND PACKAGE	
			L	W	H	L	W	H	Kg	Lbs	Kg	Lbs
6N4-2A-8	6	4	71	71	94	2 13/16	2 13/16	3 11/16	0.60	1.32	1.17	2.58

### Dimension

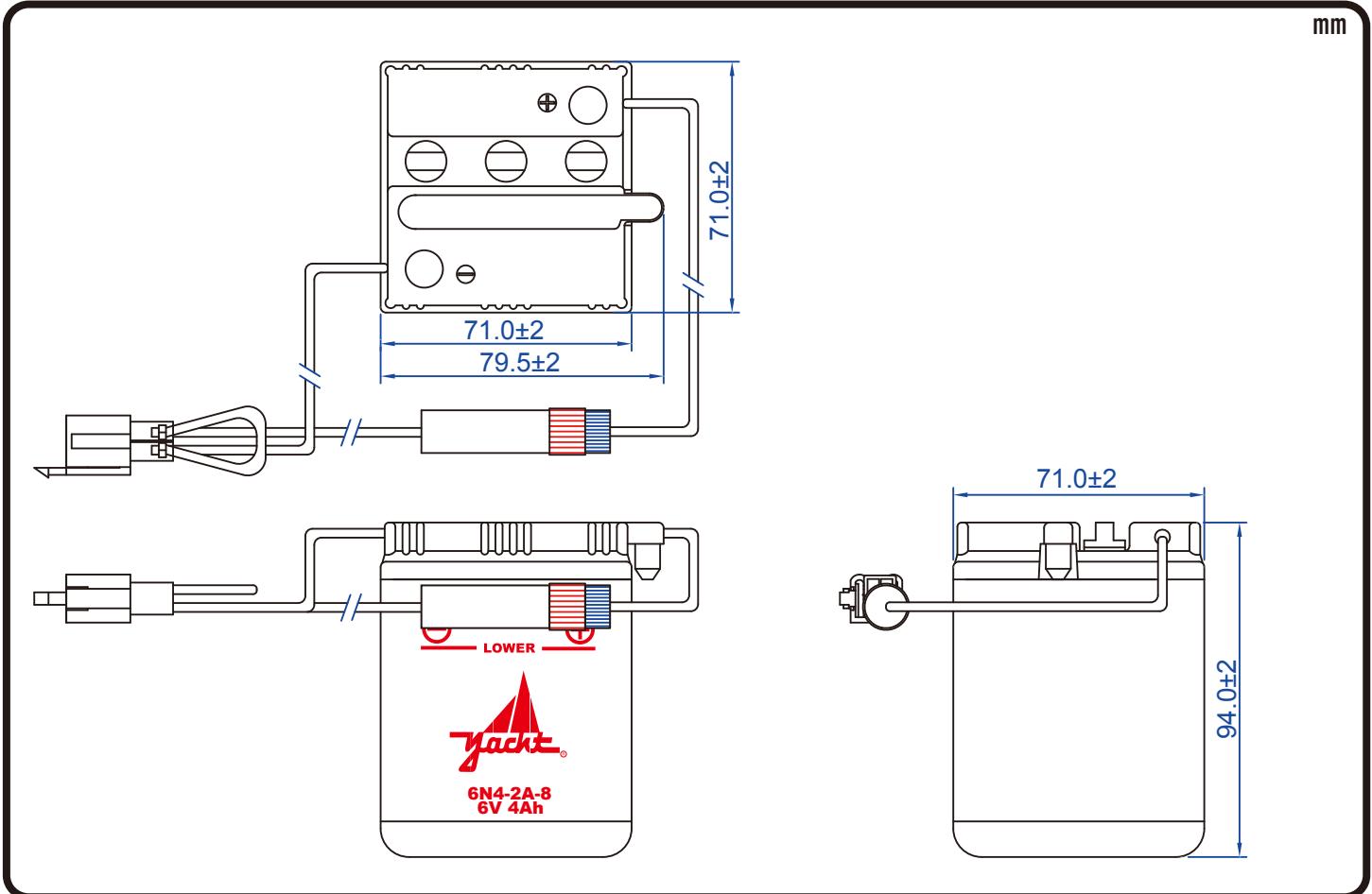

### Terminal

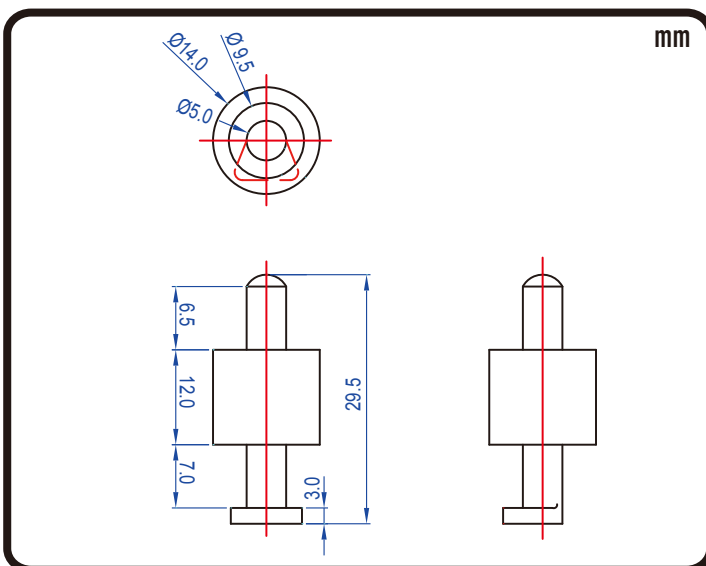

### Wire

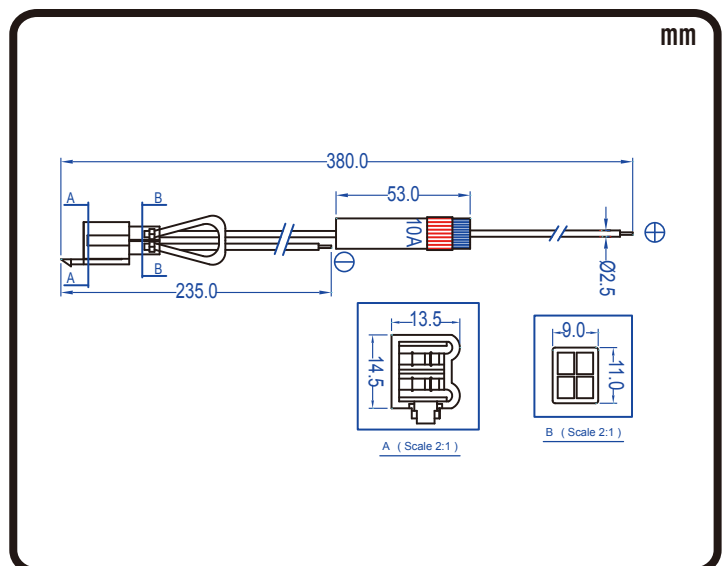

#### CORPORATE HEADQUARTERS (TAICHUNG, TAIWAN)

4F-5, No. 925, Sec. 4, Taiwan Blvd., Taichung, 40767 Taiwan, R.O.C.  
Tel : 886-4-2358-0578 Fax : 886-4-2358-0059  
sales@yacht-battery.com

#### YACHT BATTERY USA, INC.

Tel : 1-610-689-0443 Fax : 1-888-373-6466  
Dave.Beidler@yacht-battery.com  
Bruce.Ash@yacht-battery.com