



POWERSPORTS BATTERY

6-Volt Conventional Battery Series

6N2-2A-4 6V 2AH(10HR)



JIS
D5302

Specification

BATTERY TYPE NUMBER	VOLTAGE (V)	CAPACITY AH (10HR)	MAXIMUM DIMENSIONS						WEIGHT			
			MILLIMETERS(±2 mm)			INCHES (±1/16 in)			BATTERY ONLY		INCLUDE ACID AND PACKAGE	
			L	W	H	L	W	H	Kg	Lbs	Kg	Lbs
6N2-2A-4	6	2	70	46	97	2 3/4	1 13/16	3 13/16	0.40	0.88	0.90	1.98

Dimension

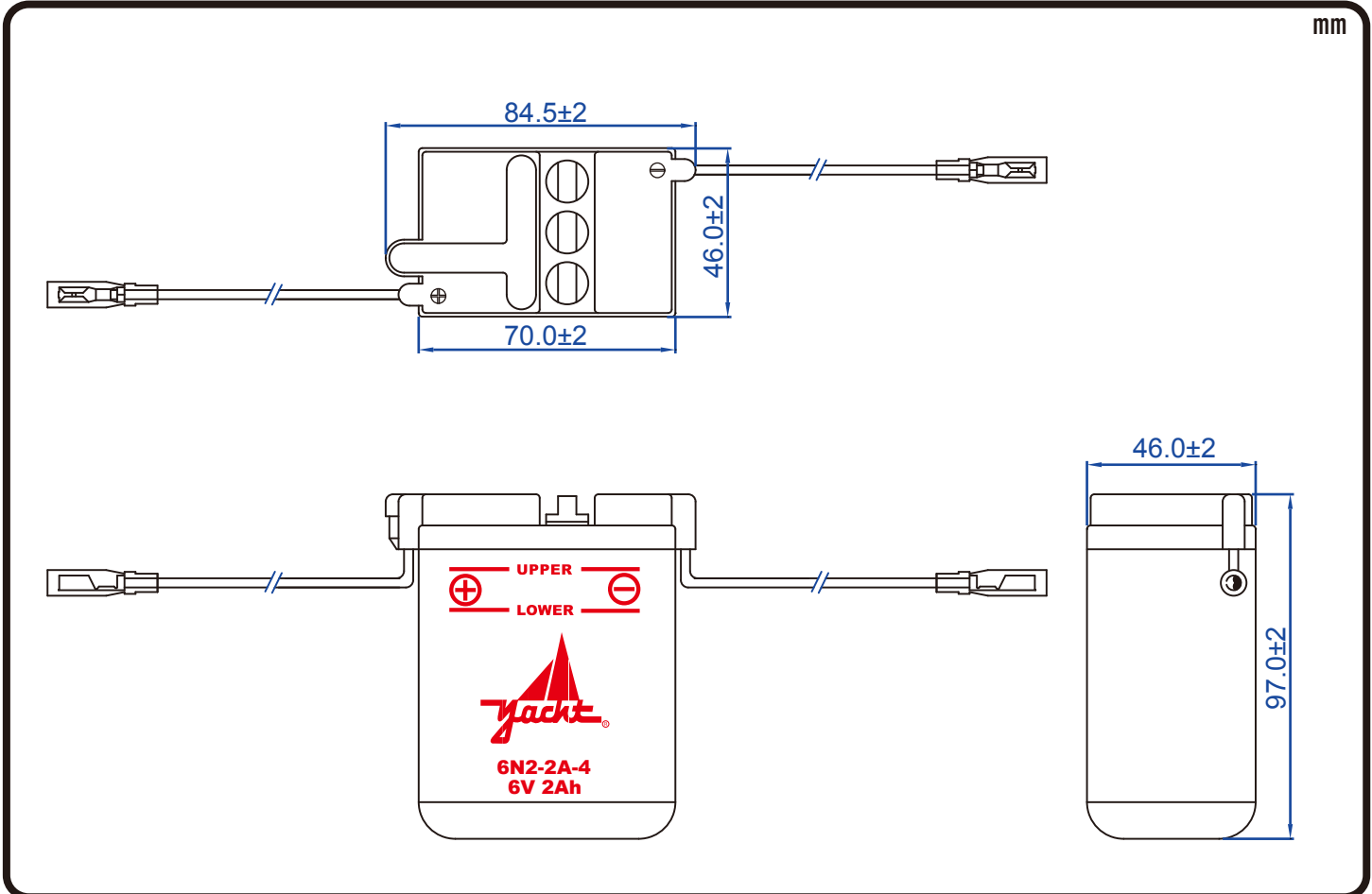

Terminal

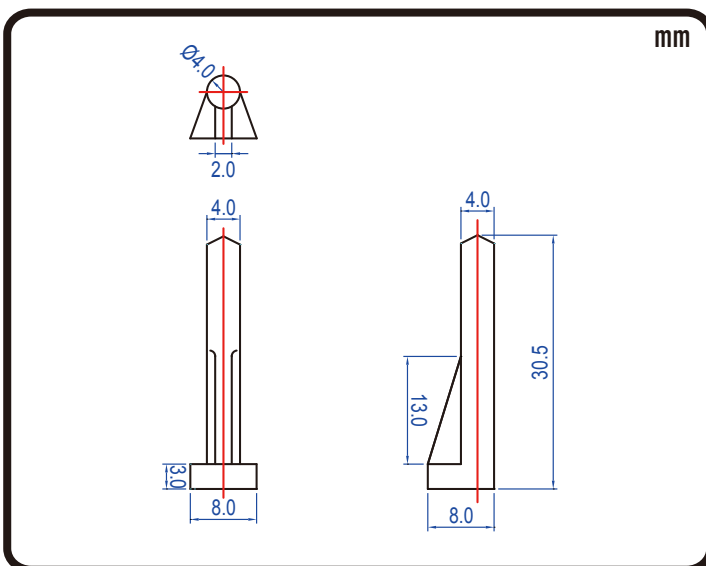

Wire

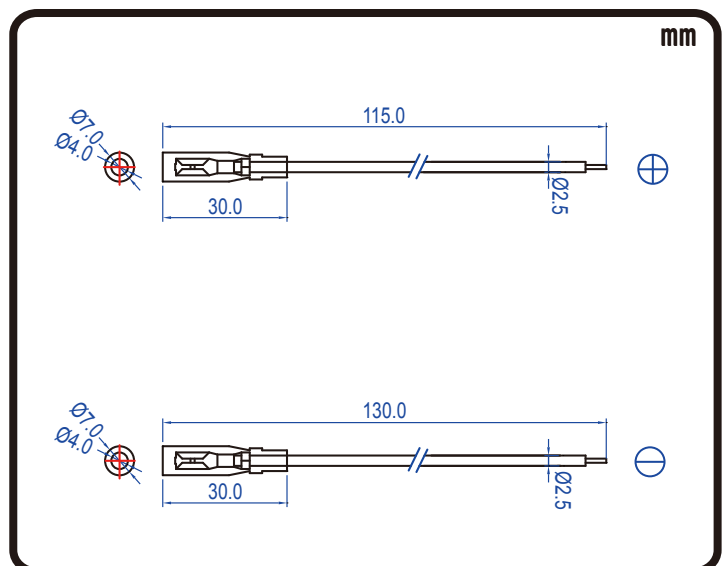

CORPORATE HEADQUARTERS (TAICHUNG, TAIWAN)

4F-5, No. 925, Sec. 4, Taiwan Blvd., Taichung, 40767 Taiwan, R.O.C.
Tel : 886-4-2358-0578 Fax : 886-4-2358-0059
sales@yacht-battery.com

YACHT BATTERY USA, INC.

Tel : 1-610-689-0443 Fax : 1-888-373-6466
Dave.Beidler@yacht-battery.com
Bruce.Ash@yacht-battery.com