



POWERSPORTS BATTERY 12-Volt Conventional Battery Series

12N18-3B 12V 18AH(10HR)



JIS D5302

Specification

BATTERY TYPE NUMBER	VOLTAGE (V)	CAPACITY AH (10HR)	MAXIMUM DIMENSIONS						WEIGHT			
			MILLIMETERS(±2 mm)			INCHES (±1/16 in)			BATTERY ONLY		INCLUDE ACID AND PACKAGE	
			L	W	H	L	W	H	Kg	Lbs	Kg	Lbs
12N18-3B	12	18	205	90	162	8 1/16	3 9/16	6 3/8	4.30	9.47	6.58	14.49

Dimension

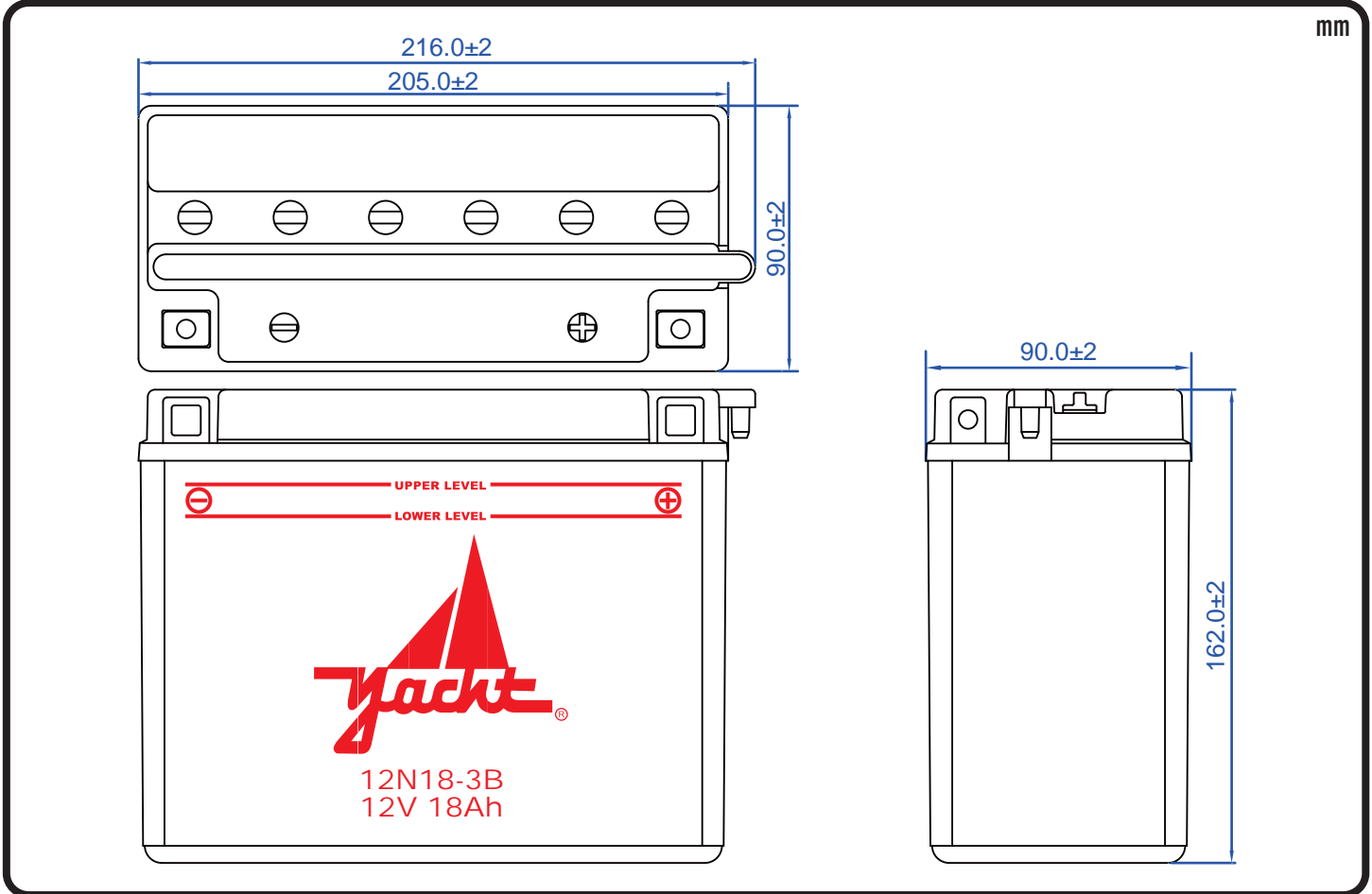

Terminal Configuration

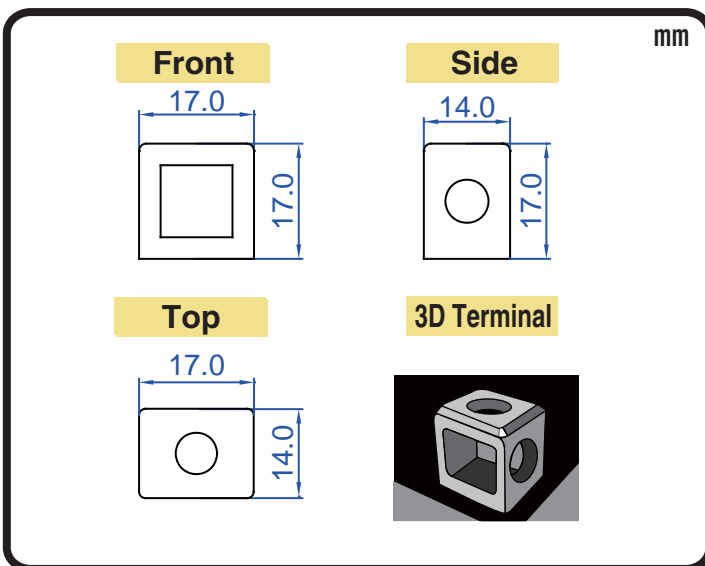

Nut & Bolt Hardware Kits

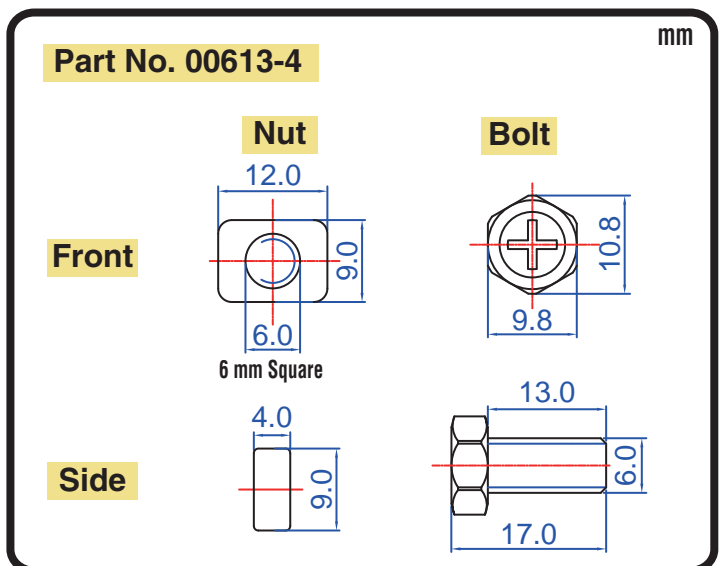

CORPORATE HEADQUARTERS (TAICHUNG, TAIWAN)
 4F-5, No. 925, Sec. 4, Taiwan Blvd., Taichung, 40767 Taiwan, R.O.C.
 Tel : 886-4-2358-0578 Fax : 886-4-2358-0059
 sales@yacht-battery.com

YACHT BATTERY USA, INC.
 Tel : 1-610-689-0443 Fax : 1-888-373-6466
 Dave.Beidler@yacht-battery.com
 Bruce.Ash@yacht-battery.com