



# POWERSPORTS BATTERY 12-Volt Conventional Battery Series

## 12N16-4B 12V 16AH(10HR)



JIS  
D5302

### Specification

BATTERY TYPE NUMBER	VOLTAGE (V)	CAPACITY AH (10HR)	MAXIMUM DIMENSIONS						WEIGHT			
			MILLIMETERS (±2 mm)			INCHES (±1/16 in)			BATTERY ONLY		INCLUDE ACID AND PACKAGE	
			L	W	H	L	W	H	Kg	Lbs	Kg	Lbs
12N16-4B	12	16	173	99	156	6 13/16	3 7/8	6 1/8	4.30	9.47	6.55	14.43

### Dimension

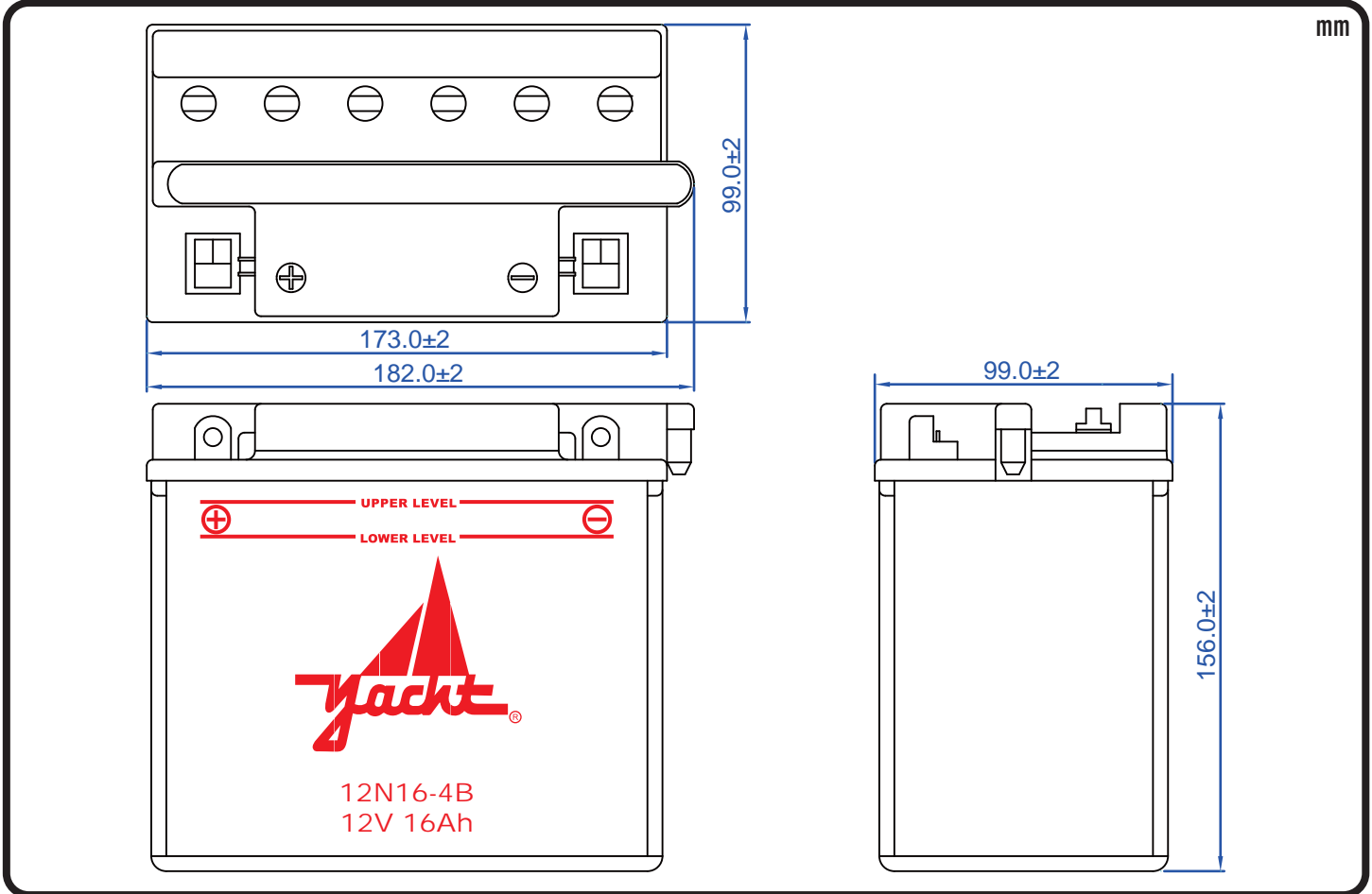

### Terminal Configuration

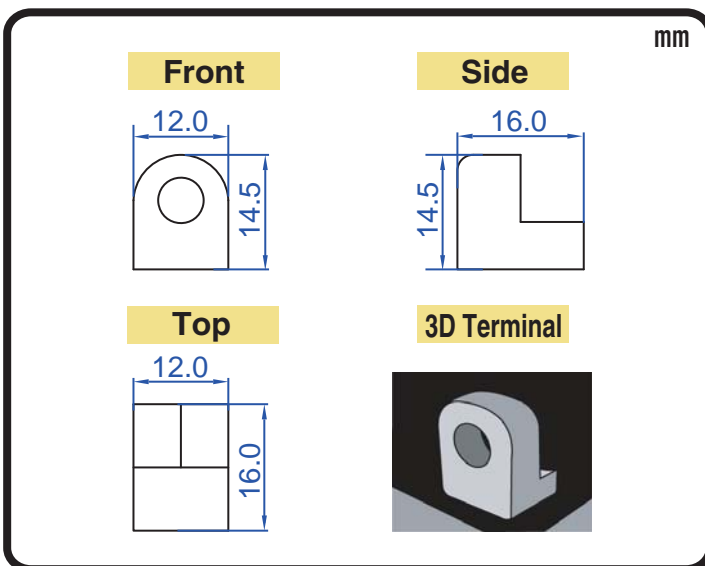

### Nut & Bolt Hardware Kits

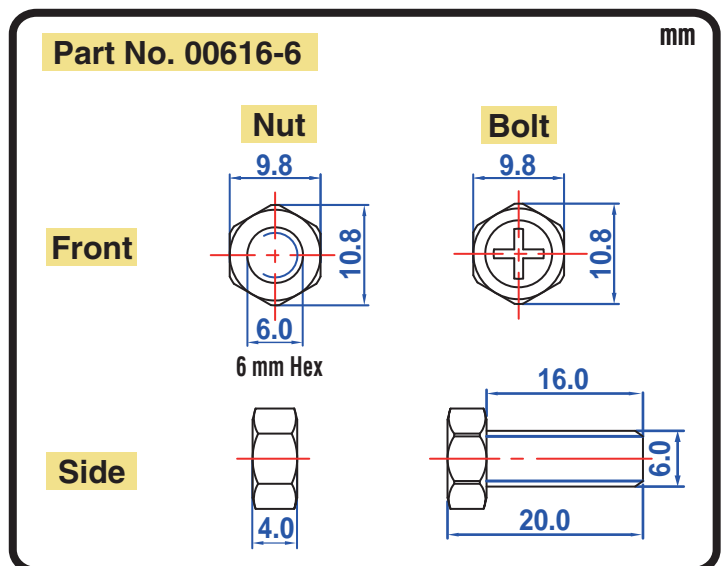

#### CORPORATE HEADQUARTERS (TAICHUNG, TAIWAN)

4F-5, No. 925, Sec. 4, Taiwan Blvd., Taichung, 40767 Taiwan, R.O.C.  
Tel : 886-4-2358-0578 Fax : 886-4-2358-0059  
sales@yacht-battery.com

#### YACHT BATTERY USA, INC.

Tel : 1-610-689-0443 Fax : 1-888-373-6466  
Dave.Beidler@yacht-battery.com  
Bruce.Ash@yacht-battery.com